



Ways forward with CERIF

João Mendes Moreira
Head of Scientific Information, FCT|FCCN
 00-0002-9081-2728

FCT Fundação para a Ciência e a Tecnologia
MINISTÉRIO DA CIÊNCIA, TECNOLOGIA E ENSINO SUPERIOR

 GOVERNO DE PORTUGAL | MINISTÉRIO DA EDUCAÇÃO E CIÊNCIA

Mission



Connected Research

Ensure the **creation** and **sustained** development of **a regulatory framework and infrastructures** to implement a national integrated information ecosystem ([PTCRIS](#)) to support research management

Goals

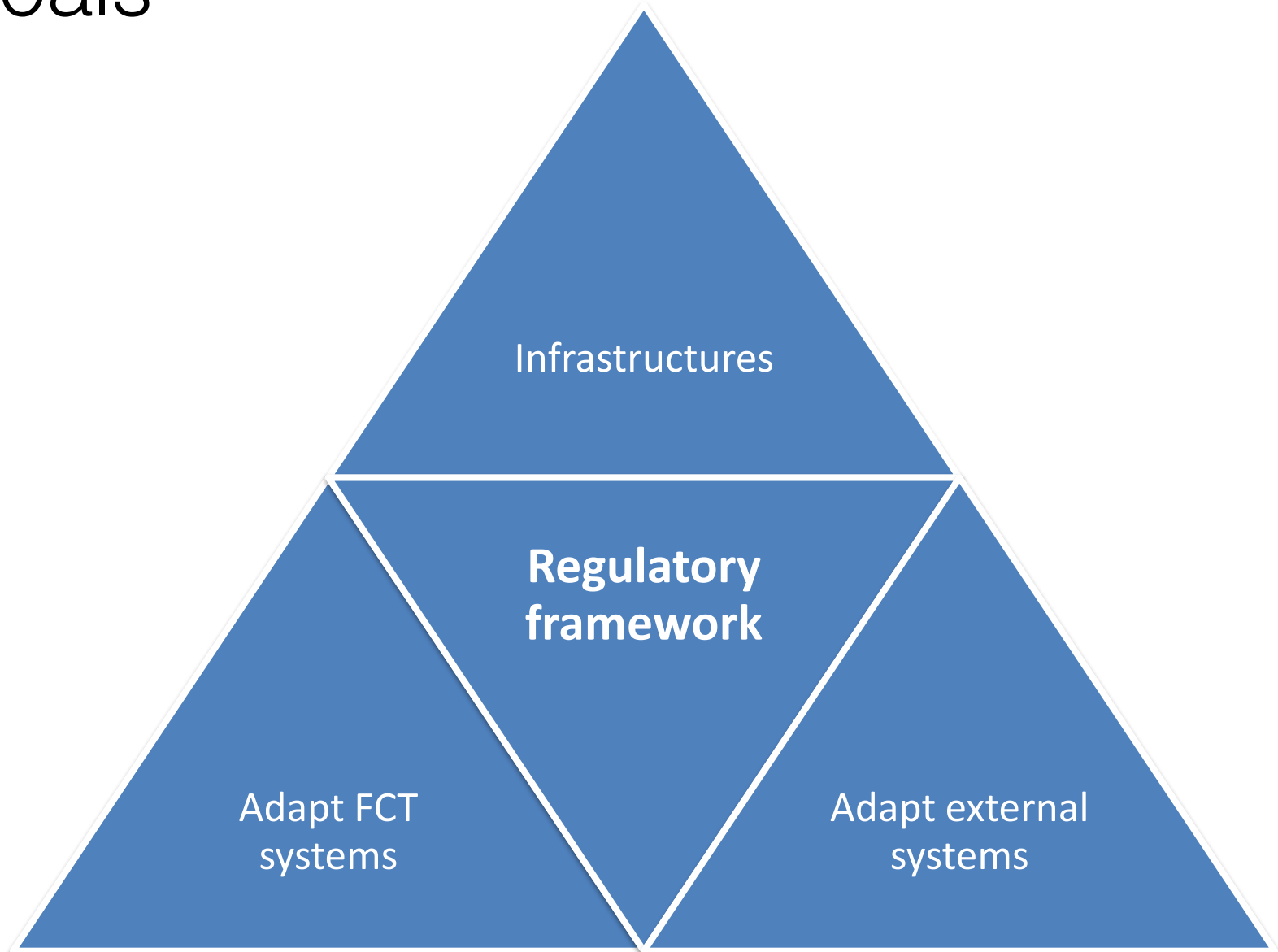

CRIS chain value

Program

Services

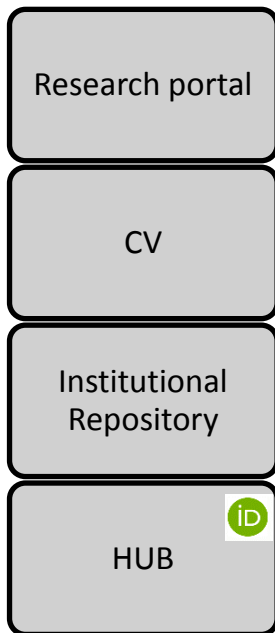

Infraestructures

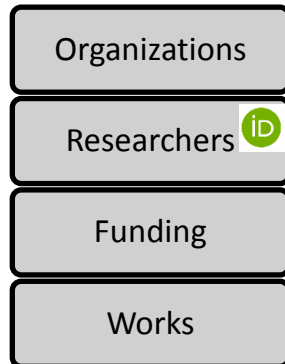

Regulatory framework

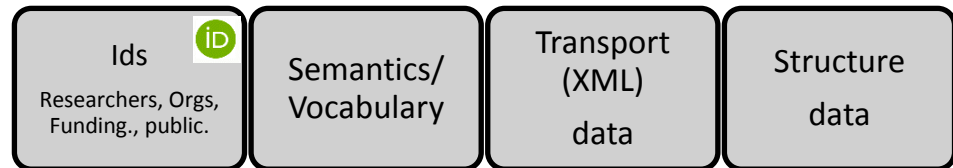

Stage 0

- Funding -
Seed capital

Services

Infraestruturas

Regulatory framework

Id Resear.



Ids Orgs



Semantics /
Vocabulary



Data / XML



Stage 1

Serviços



Research Portal



Infraestruturas

Organizações

Projetos

Investigadores

Reconciliação
Teses / OrgIDs



PTCRISync

Quadro normativo

Ids Autores



Ids Orgs



Semantica /
Vocabulário



Modelo
dados



PTCRIS

Connected Research

National CV platform

FCT Fundação para a Ciência e a Tecnologia
MINISTÉRIO DA CIÊNCIA, TECNOLOGIA E ENSINO SUPERIOR



GOVERNO DE
PORTUGAL

MINISTRO DA CIÊNCIA,
TECNOLOGIA E ENSINO SUPERIOR

Ciência Vitae



Ciência Vitae



JOAO MENDES MOREIRA

LESI (Licenciature)

Ciência ID 3015-4047-6307

Citation name Alexandre, Reis Mendes Moreira João

Contacts jmm@fccn.pt

IDENTIFICATION EDUCATION PROFESSIONAL CAREER PROJECTS PRODUCTIONS ACTIVITIES DISTINCTIONS



SUMMARY OF ACTIVITIES, PRODUCTIONS AND PROJECTS

▶ ACTIVITIES (0)

▶ PRODUCTIONS (6)

▶ PROJECTS (2)

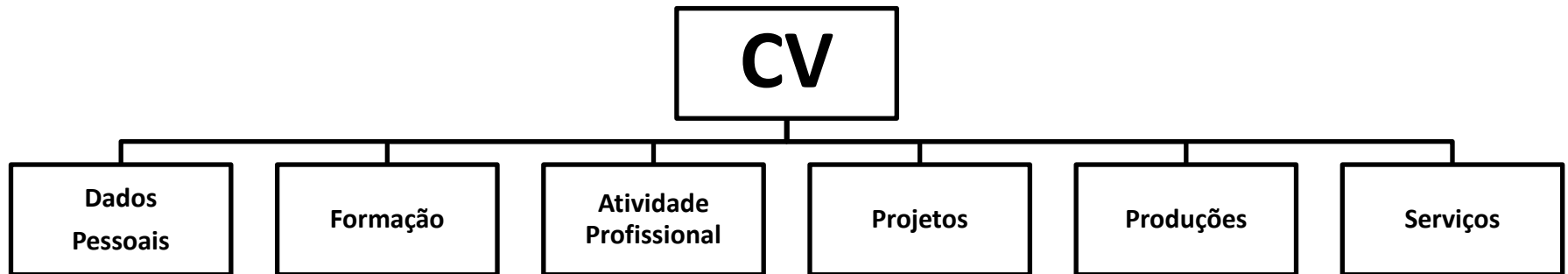

Ciência Vitae – Interoperability / Usability

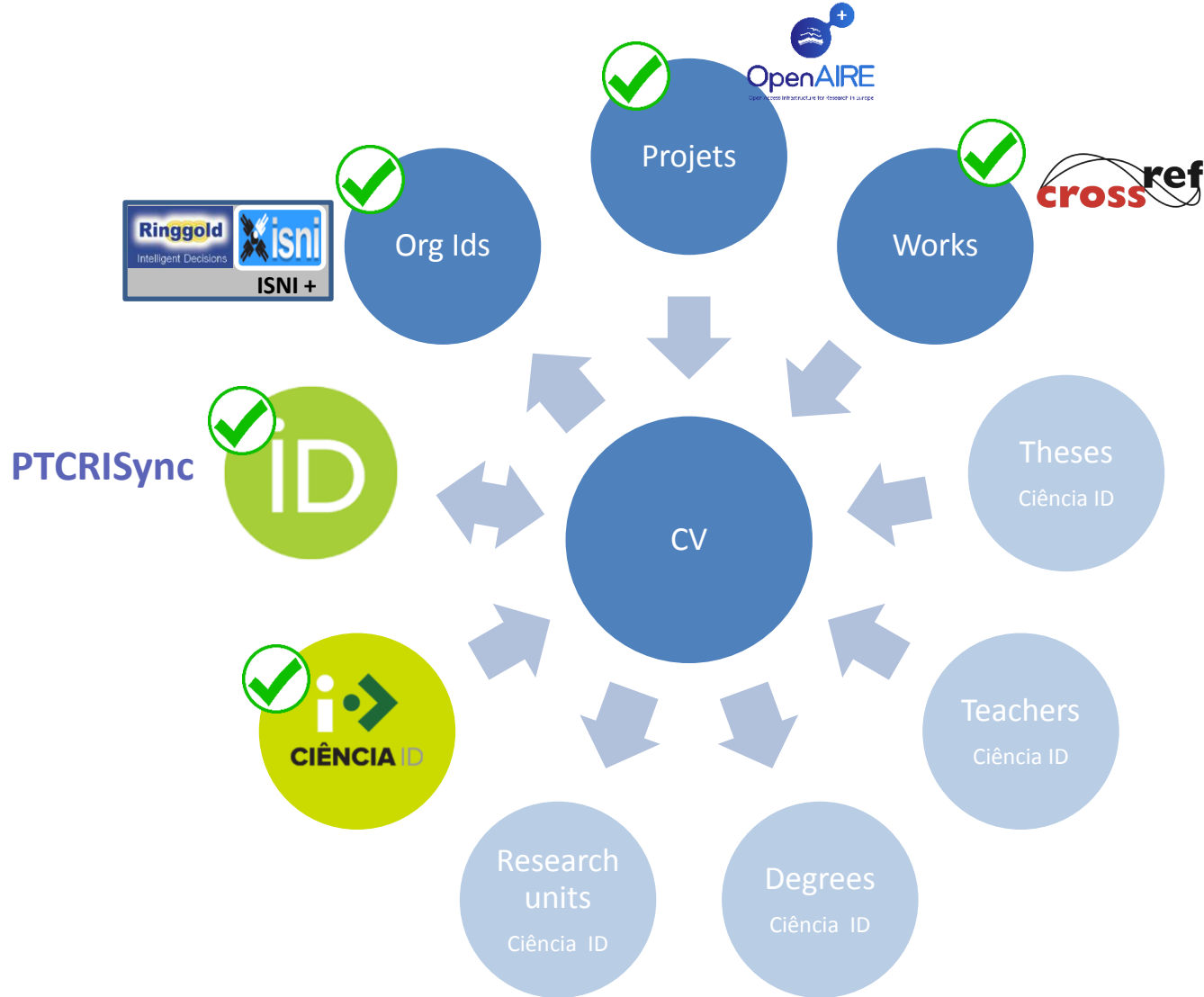

Ciência Vitae – Organizations

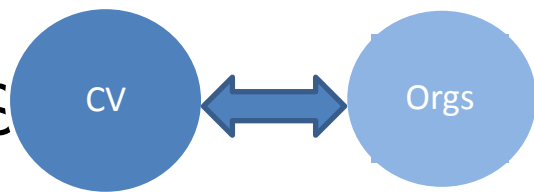

CIÊNCIAVITAE Joao Moreira Ciência Vitae público 

IDENTIFICAÇÃO FORMAÇÃO PERCURSO PROFISSIONAL PROJETOS PRODUCÇÕES ATIVIDADES DISTINCÇÕES

FORMAÇÃO

ADD EDUCATION



Institution *

- Universidade do Minho**
Braga, Braga, academic
- Universidade do Minho Escola de Engenharia**
Guimaraes, academic/eng
- Universidade do Minho Escola de Ciências da Saúde**
Braga, academic/medsch
- Universidade do Minho Instituto de Educação**
Braga, academic/gen
- Universidade do Minho - Campus de**

Department

Degree/title

Start date

Year ▾ Month ▾ Day ▾

End date (leave blank if current)

Year ▾ Month ▾ Day ▾

Add to list Cancel

PTCRIS

Connected Research

Use case 1 – CV platform – Funding

FCT Fundação para a Ciência e a Tecnologia
MINISTÉRIO DA CIÊNCIA, TECNOLOGIA E ENSINO SUPERIOR



GOVERNO DE
PORTUGAL

MINISTRO DA CIÊNCIA,
TECNOLOGIA E ENSINO SUPERIOR

Ciência Vitae – Funding

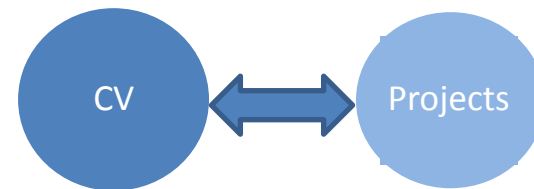

 **CIÊNCIAVITAE** Joao Moreira public Ciência Vitae 

IDENTIFICATION EDUCATION PROFESSIONAL CAREER **PROJECTS** PRODUCTIONS ACTIVITIES DISTINCTIONS 

PROJECTS

▼ TYPE OF PARTICIPATION *

Investigation role

Project leader

Start date of participation *

2011

01

01

▼ PROJECT INFORMATION *

Project title * 

The Power of Science

The Power of Science. German Science in Portugal (1933-45)

Developing the Instructional Power of Modern Personal Computing (Computer Science)

Doctoral Dissertation Research in Political Science: Does Power Corrupt? An Experimental Approach To Explore the Origins of Corruption in Africa

Landscape of Resistance. Science, power, and environmental justice in the struggle over garbage and incinerators in contemporary Naples, Italy

Ciência Vitae – Funding

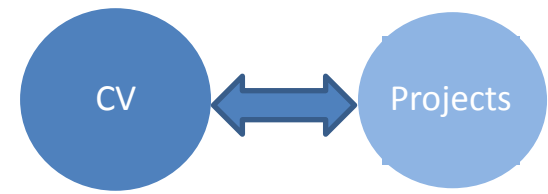

The screenshot shows the 'CIÊNCIAVITAE' interface. At the top, the user 'Joao Moreira' is logged in as 'public Ciência Vitae'. The navigation menu includes 'IDENTIFICATION', 'EDUCATION', 'PROFESSIONAL CAREER', 'PROJECTS', 'PRODUCTIONS', 'ACTIVITIES', and 'DISTINCTIONS'. The 'PROJECTS' section is active, displaying a list of projects with filters for 'Recent start date' and 'View all types'. Two projects are listed:

- Data Flows Data Mining Distributed**
Grant done from 2010 to 2013
Synchronize with
- TriAna - Travel time prediction and analysis for decision support to mass transport companies**
Grant done from 2005 to 2008
Synchronize with

At the bottom of the page, there are 'SYNCHRONIZE' and 'CANCEL' buttons. A mouse cursor is pointing at the 'SYNCHRONIZE' button.

Ciência Vitae – Funding

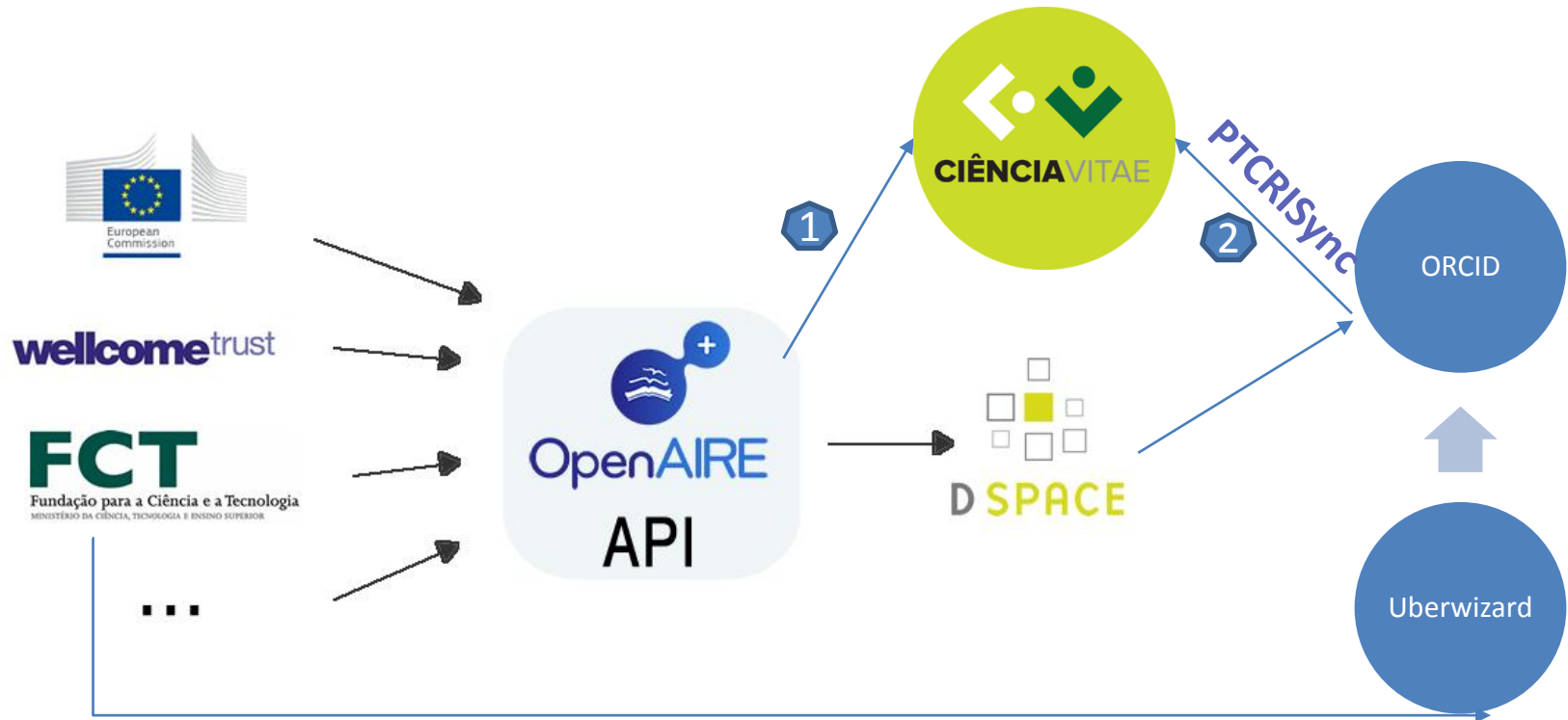
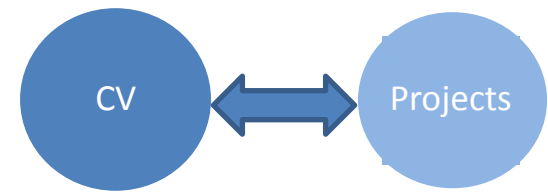

Funding – ORCID – OpenAIRE

- Vocabulary / semantics

ORCID	CASRAI	OpenAIRE
Award	?	Award
Contract	Contract	Contract
Grant	Grant	Grant
Salary award		

Ciência Vitae – Funding – OpenAIRE

Problems / Difficulties

- OpenAIRE “registry” completeness
 - Funders (european)
 - Funding (more complete)
- CERIF–XML API / OAI–PMH
 - ORCID (no)
 - OpenAIRE (no)
- Vocabulary / semantics
 - OpenAIRE / ORCID

Suggestions

- OpenAIRE:
 - Assume mng of the European funding registry
 - More control over information (ingester, validator)
- OpenAIRE/ ORCID: Implement CERIF APIs
- euroCRIS, OpenAIRE, SE/OECD
 - Recommend funders the implementation of OpenAIRE profile for CRIS
 - OECD – [Towards Data Integration for Research Funding and Performing Organisations \(SE\)](#)
- COAR / CASRAI / OpenAIRE / euroCRIS / others
 - More cooperation, clear definition of responsibilities
 - System for mng vocabulary (euroCRIS?, ORCID?, CASRAI)

PTCRIS

Connected Research

Use case 2 – Institutional Repositories

FCT Fundação para a Ciência e a Tecnologia
MINISTÉRIO DA CIÊNCIA, TECNOLOGIA E ENSINO SUPERIOR



GOVERNO DE
PORTUGAL

MINISTRO DA CIÊNCIA,
TECNOLOGIA E ENSINO SUPERIOR

Repositories & OpenAIRE

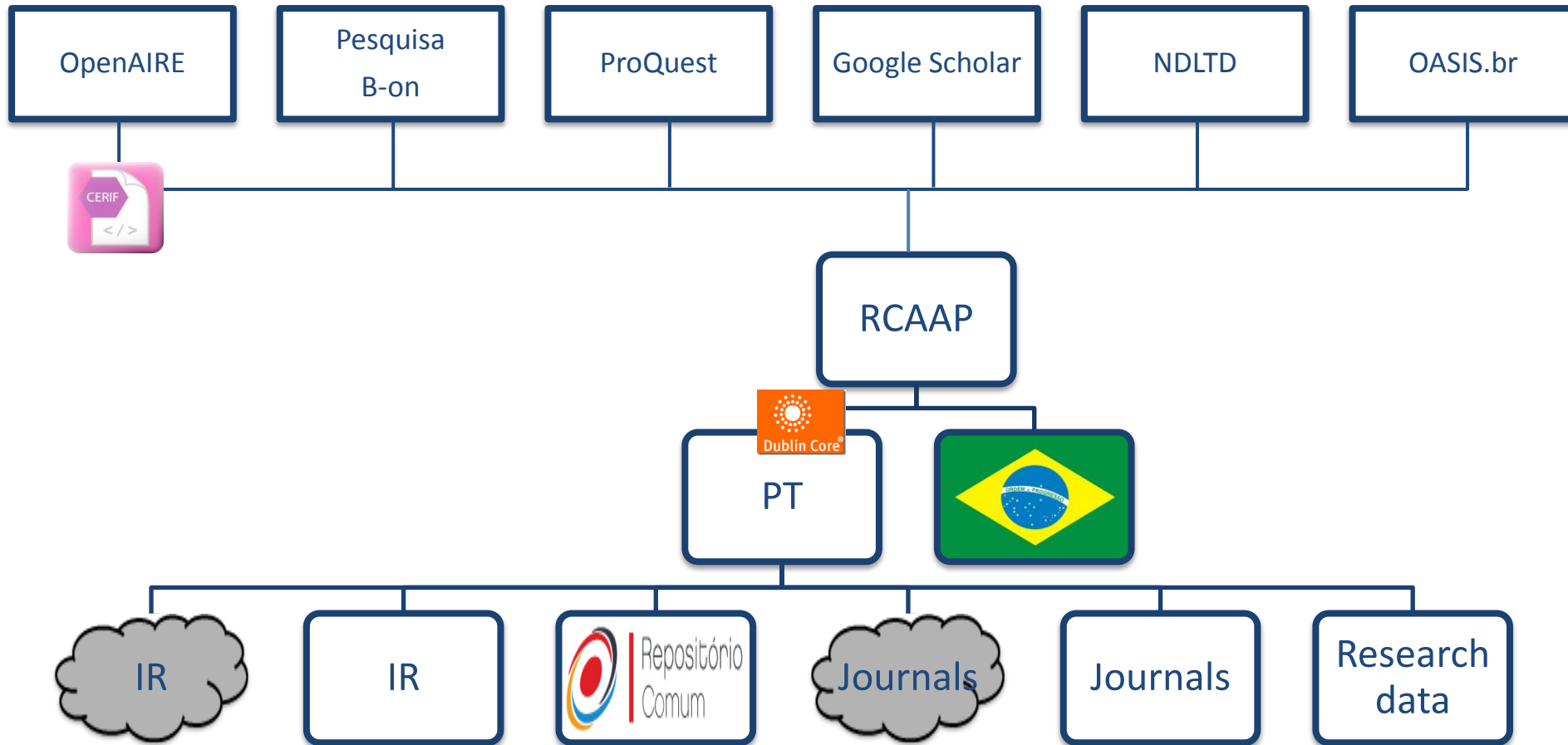
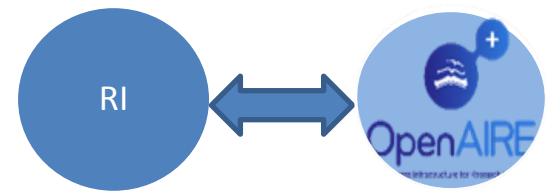

OpenAIRE Guidelines

← → ↻ <https://guidelines.openaire.eu/en/latest/> ☆ + 🔍 🗨️ 📊 🔄 🌐 🏠

OpenAIRE Guidelines
3.0

Search docs

OpenAIRE Guidelines for Literature Repositories
OpenAIRE Guidelines for Data Archives
OpenAIRE Guidelines for CRIS Managers based on CERIF-XML
Contributing
How the Horizon 2020 Open Access requirements are met

Docs » OpenAIRE Guidelines [View page source](#)

OpenAIRE Guidelines

```
1 <dc:creator>Evans, R.J.</dc:creator>
2 <dc:creator>Walker Jnr., John</dc:creator>
3 <dc:creator>
4   International Human Genome Sequencing Consortium
5 </dc:creator>
6 <dc:creator>
7   Loughborough University. Department of Computer Science
8 </dc:creator>
```



OpenAIRE Guidelines consists of three guidelines for publication repositories, data archives and CRIS systems respectively:

- [OpenAIRE Guidelines for Literature Repositories](#)
- [OpenAIRE Guidelines for Data Archives](#)
- [OpenAIRE Guidelines for CRIS Managers based on CERIF-XML](#)

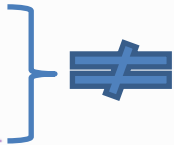

Software requirements (ex: Author Id)

Author related	
R1.1	Author's profile page (claim)
R1.2	ORCID aware every time the author is displayed
R1.3	ORCID authority control
R1.4	Search by ORCID identifier
Interoperability	
R2.1	Supporting additional metadata formats
Added value Dspace-ORCID services	
R3.1	PTCRISync (import)
R3.2	PTCRISync (export)

Joint webinar ORCID / Duraspace March 2015

Repositories & OpenAIRE

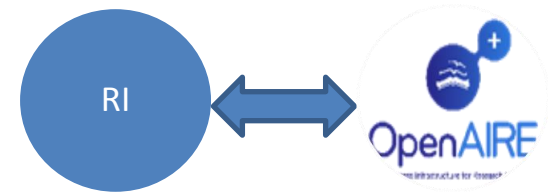

Problems / Difficulties

- [OpenAIRE Guidelines 3.0](#)
 - RI <>CRIS (completeness)
- Dspace / Software vendors
 - Insufficient data structure
 - Insufficient functionalities to handle quality metadata (ORCID)
 - No CERIF-XML implementation

Suggestions

- OpenAIRE
 - enrich DC profile
- OpenAIRE, euroCRIS, COAR,
 - Encourage software vendors to comply with standards (source problem solving approach) (ex: DSpaceCRIS)
- ALL
 - Lobby software organizations (need to become members!)

Ciência Vitae – Repositories

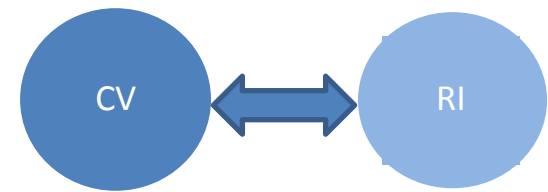

CIÊNCIAVITAE João Moreira Ciência Vitae Público 

IDENTIFICAÇÃO FORMAÇÃO PERCURSO PROFISSIONAL PROJETOS PRODUÇÕES ATIVIDADES DISTINÇÕES 

CIÊNCIAVITAE João Moreira Ciência Vitae Público 

IDENTIFICAÇÃO FORMAÇÃO PERCURSO PROFISSIONAL PROJETOS PRODUÇÕES ATIVIDADES DISTINÇÕES 

PRODUÇÕES > DEPOSITAR NO REPOSITÓRIO

Data mais recente Ver todos os tipos 20

Ações	Produção	Estado
	Ferreira Dias e a constituição da Companhia Nacional de Electricidade Artigo em revista publicado em 1996 source-work-id: CV:912977799216; eid: 2-s2.0-84889795757; source-work-id: DG:912977799216	A aguardar
Enviar	Portugal e o Plano Marshall: história de uma adesão a contragosto (1947-1952) Artigo em revista publicado em 1994 source-work-id: CV:521299999218; doi: 10.2307/41011190; source-work-id: DG:521299999218	

Ciência Vitae – Repositories

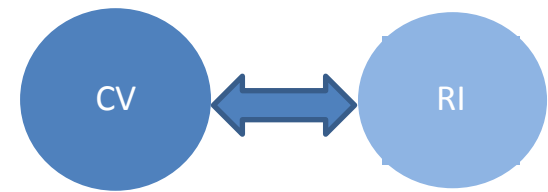

Problems / Difficulties

- Semantics (publication types)
 - ORCID
 - OpenAIRE
 - CASRAI
 - COAR

Suggestions

- Create and manage a common tool for managing semantics

PTCRIS

Connected Research

Use case 3a – CERIFying non native CERIF applications

Ciência Vitae – CERIF–XML

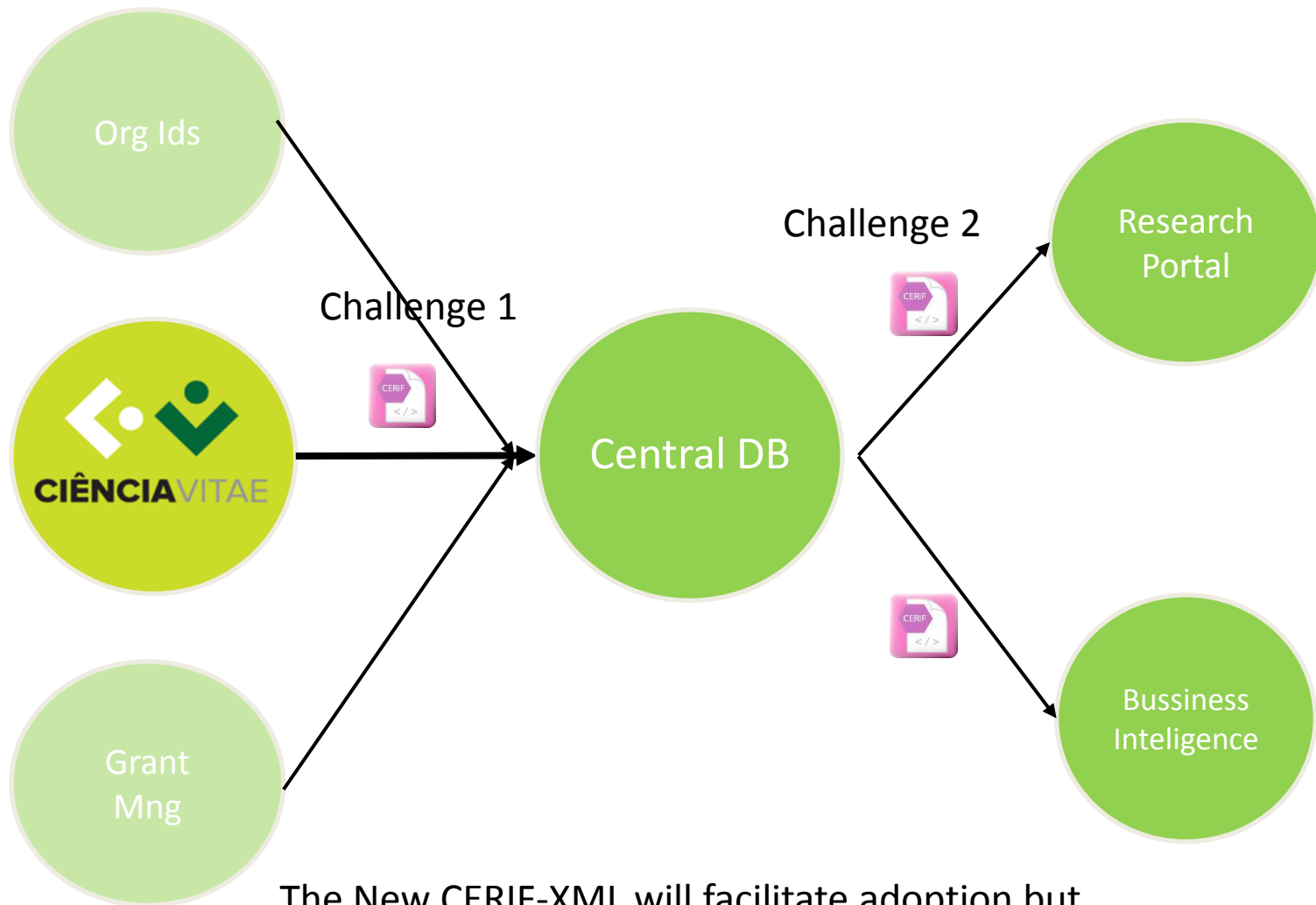
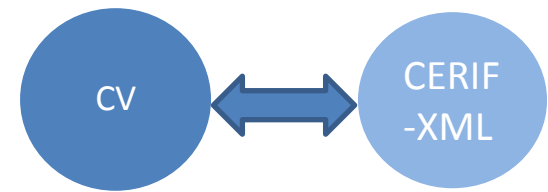

The New CERIF-XML will facilitate adoption but ...

Non native CERIF application – Toolkit?

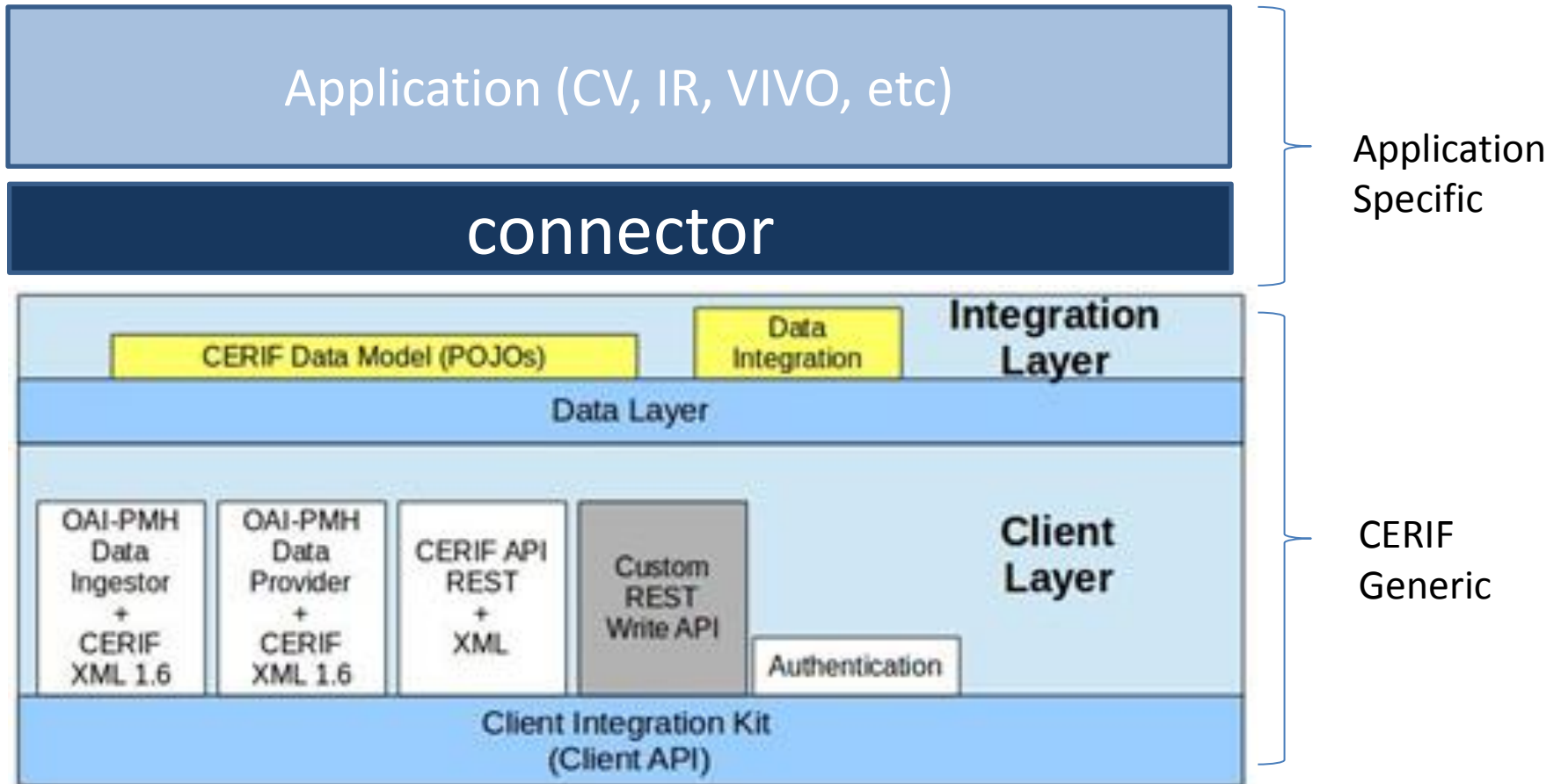

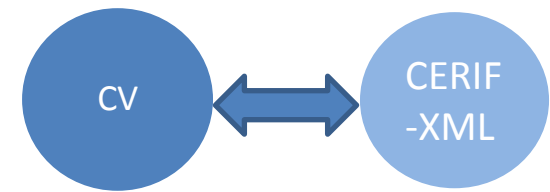

Problems / Difficulties

- Data provider
 - No CERIF-XML Specs for profile Academic funding CV
 - Except for EKT, open source (small part) there are no tools
- Research Portal
 - C1: cc-refim [Portal](#) is not open source
 - C2: VIVO does not ingest CERIF-XML

Suggestions

- EuroCRIS / CASRAI
 - Implement a CERIF profile for the academic funding CV
 - Develop and maintain a toolkit to accelerate software adoption of CERIF-XML (over OAI-PMH)
- All
 - Lobby software vendors to adopt CERIF-XML / OAI-PMH

PTCRIS

Connected Research

Use case 3b – Building applications using Native CERIF infrastructure

FCT Fundação para a Ciência e a Tecnologia
MINISTÉRIO DA CIÊNCIA, TECNOLOGIA E ENSINO SUPERIOR



GOVERNO DE
PORTUGAL

MINISTRO DA CIÊNCIA,
TECNOLOGIA E ENSINO SUPERIOR

CERIF native application – Toolkit?

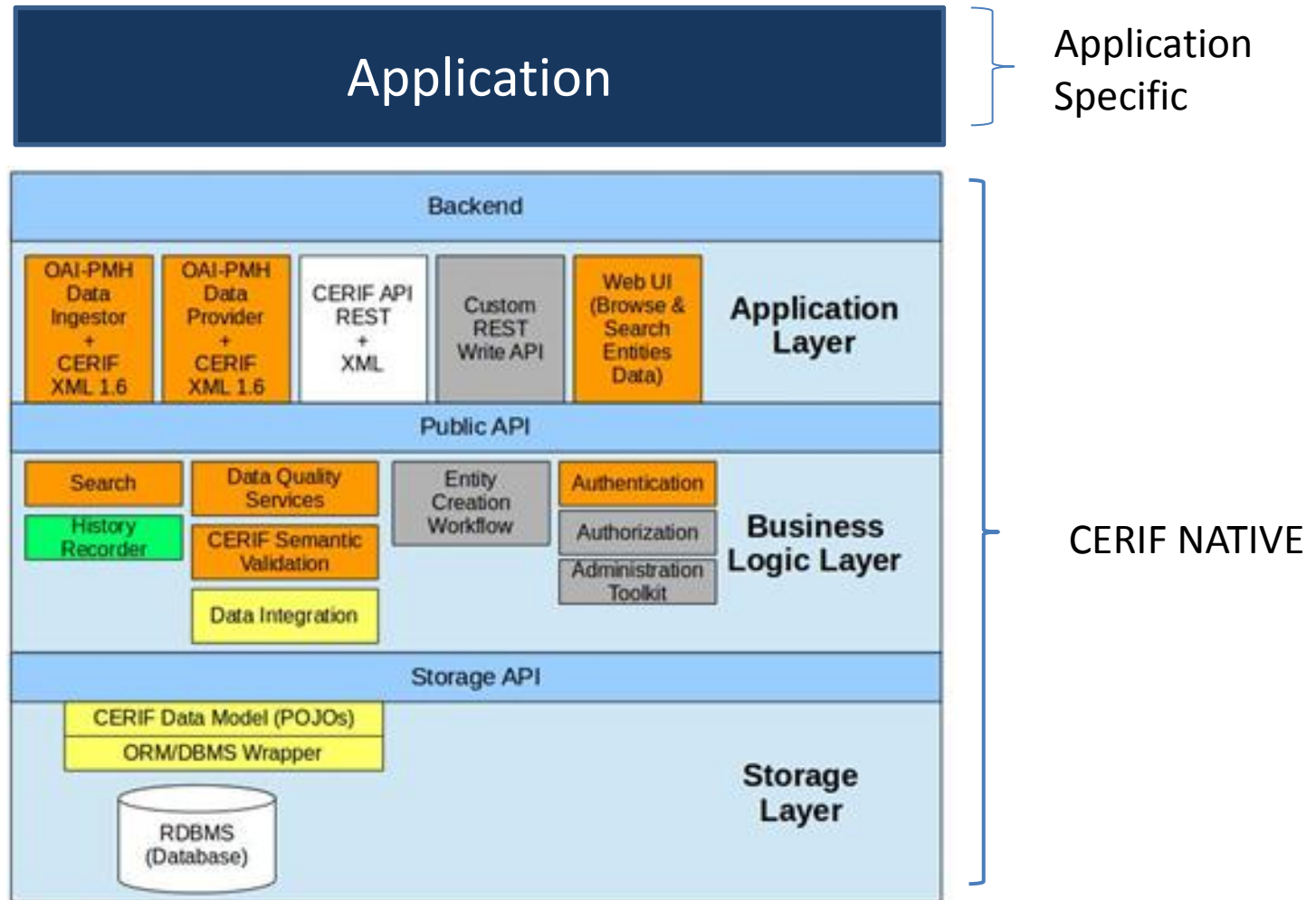

Global suggestions

- Increase partners cooperation and alignment
 - Create an alliance for research management?
 - Define clear areas of responsibility between partners
 - Improve cooperation on strategic and activity plans
- euroCRIS
 - Create a software repository for software of common interest
 - Decide main tools to develop and maintain (sustainability)?
 - Increase work force (requires new funding model)
 - Partnership with DuraSpace?
- Software partners
 - Align and engage with standards and guidelines
- ALL : Lobby activity
 - Become member of main associations (euroCRIS, ORCID, CASRAI, COAR)
 - Take a voice on strategy and activity plan of these associations

PTCRIS

Connected Research

Cooperation is power!

FCT Fundação para a Ciência e a Tecnologia
MINISTÉRIO DA CIÊNCIA, TECNOLOGIA E ENSINO SUPERIOR



GOVERNO DE
PORTUGAL

MINISTRO DA CIÊNCIA,
TECNOLOGIA E ENSINO SUPERIOR